



Semi-Custom Cabinetry Catalogue

Precision manufacturing
semi-custom flexibility

2025

CH CEMAHOME

FIRPLAK

Inspiring your projects:
our expertise, your success.



Turnkey solution

Complete solution, from design to installation



Surfaces solutions

Kitchen & Bath countertops available.



Semi-Custom Cabinetry

Colors and sizes flexibility.



Nearshoring

No tariff, 60-day delivery, and affordable shipping.



Cost engineering

We adapt to your budget by adjusting design, materials, hardware, and logistics.



American - Colombian partnership

30 years of experience in US market.

45 years
of manufacturing expertise,
30 years
serving the US.

140,000+
sq ft industrial
complex.

100+ projects
completed,
15,000+ units
furnished in the US.

Our numbers speak for themselves

**Distribution
network**
in 16+ countries.

25+ Specialists
dedicated to R&D,
design, and
quality control.

300+
employees.

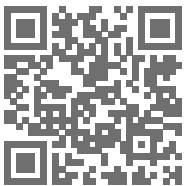

> Discover our cabientry
manufacturing facility

CH CEMAHOME

FIRPLAK

Semi-Custom Cabinetry Features

Made from CARB-compliant
Melamine particle board.



Versatile and durable
material



15mm or 18mm structure
with 0.5mm edgebanding



18mm doors with 1mm
edgebanding



Nail-free construction
with dowels



Single component
quality checked



Hardware based on
budget and design



Carb2 Board



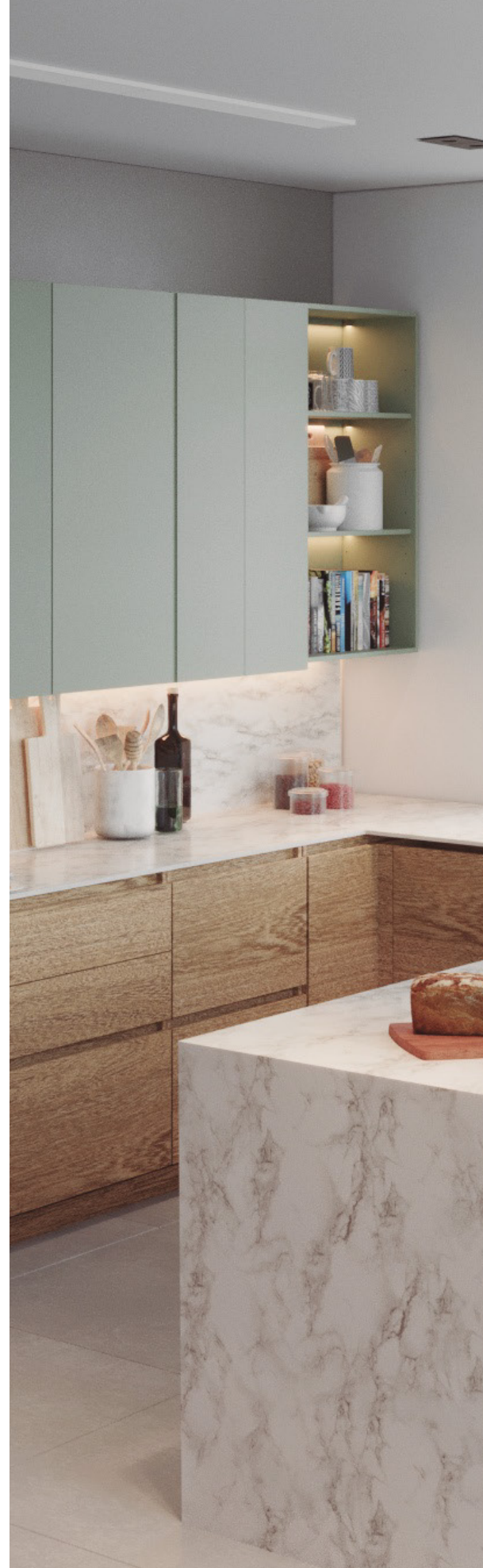

Particleboard with low formaldehyde emissions,
certified under **CARB ASTM Phase II / TSCA regulations.**



Door styles

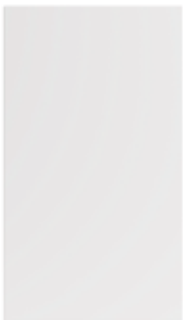





Slab

Colors				
Blanco	Glacial	Cinza	Mitte	Sagano
				



Shaker

Colors				
Blanco	Glacial	Cinza	Mitte	Sagano
				



Upper cabinets

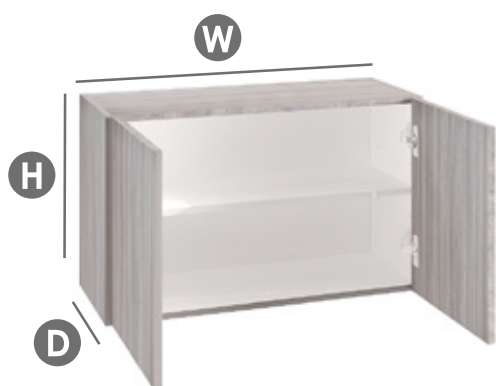

W - Wall cabinet for appliances (Double door)

COD	Width	Height	Depth	Shelves
W3012	30"	12"	12" / 24"	0
W3312	33"	12"	12" / 24"	0
W3612	36"	12"	12" / 24"	0
W3015	30"	15"	12" / 24"	0
W3315	33"	15"	12" / 24"	0
W3615	36"	15"	12" / 24"	0
W3018	30"	18"	12" / 24"	1
W3318	33"	18"	12" / 24"	1
W3618	36"	18"	12" / 24"	1
W3021	30"	21"	12" / 24"	1
W3321	33"	21"	12" / 24"	1
W3621	36"	21"	12" / 24"	1

Setting

- Door
- Shelf



W - Wall cabinet (Single door)

COD	Width	Height	Depth	Shelves
W1230	12"	30"	12"	2
W1530	15"	30"	12"	2
W1830	18"	30"	12"	2
W2130	21"	30"	12"	2
W1236	12"	36"	12"	2
W1536	15"	36"	12"	2
W1836	18"	36"	12"	2
W2136	21"	36"	12"	2
W1242	12"	42"	12"	3
W1542	15"	42"	12"	3
W1842	18"	42"	12"	3
W2142	21"	42"	12"	3

Setting

- Door
- Shelves

Upper cabinets



W - Wall cabinet (Double door)

COD	Width	Height	Depth	Shelves
W2430	24"	30"	12"	2
W2730	27"	30"	12"	2
W3030	30"	30"	12"	2
W3330	33"	30"	12"	2
W3630	36"	30"	12"	2
W2436	24"	36"	12"	2
W2736	27"	36"	12"	2
W3036	30"	36"	12"	2
W3336	33"	36"	12"	2
W3636	36"	36"	12"	2
W2442	24"	42"	12"	3
W2742	27"	42"	12"	3
W3042	30"	42"	12"	3
W3342	33"	42"	12"	3
W3642	36"	42"	12"	3

Setting

- Doors
- Shelves

Lower cabinets



B - Base (Single door)

COD	Width	Height	Depth
B12	12"	30"	24"
B15	15"	30"	24"
B18	18"	30"	24"
B21	21"	30"	24"

Setting

- Drawer
- Door
- Shelf



B - Base (Double door)

COD	Width	Height	Depth
B24	24"	30"	24"
B27	27"	30"	24"
B30	30"	30"	24"
B33	33"	30"	24"
B36	36"	30"	24"

Setting

- Drawer
- Doors
- Shelf



BFD - Base Full Door (Single door)

COD	Width	Height	Depth
BFD12	12"	30"	24"
BFD15	15"	30"	24"
BFD18	18"	30"	24"
BFD21	21"	30"	24"

Setting

- Door
- Shelf

Lower cabinets



BFD - Base Full Door (Double door)

COD	Width	Height	Depth
BFD30	30"	30"	24"
BFD33	33"	30"	24"
BFD36	36"	30"	24"
BFD39	39"	30"	24"

Setting

- Doors
- Shelf

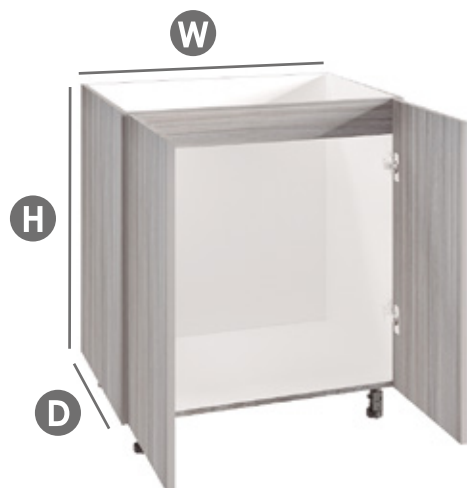

SBFD - Sink Base Full Door (Double door)

COD	Width	Height	Depth
SBFD30	30"	30"	24"
SBFD33	33"	30"	24"
SBFD36	36"	30"	24"
SBFD39	39"	30"	24"

Setting

- Doors

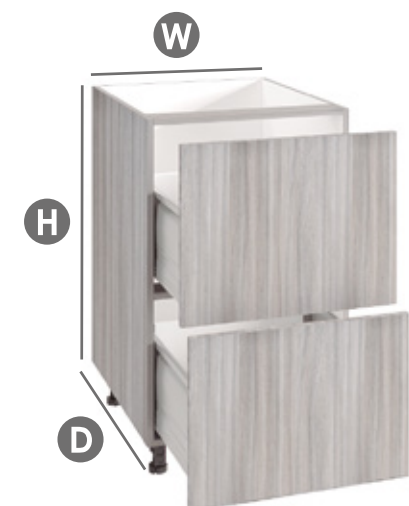

DB-2 - Drawer Base

COD	Width	Height	Depth
DB12-2	12"	30"	24"
DB15-2	15"	30"	24"
DB18-2	18"	30"	24"
DB21-2	21"	30"	24"
DB24-2	24"	30"	24"
DB27-2	27"	30"	24"
DB30-2	30"	30"	24"
DB36-2	36"	30"	24"

Setting

- Two identical drawers

Lower cabinets

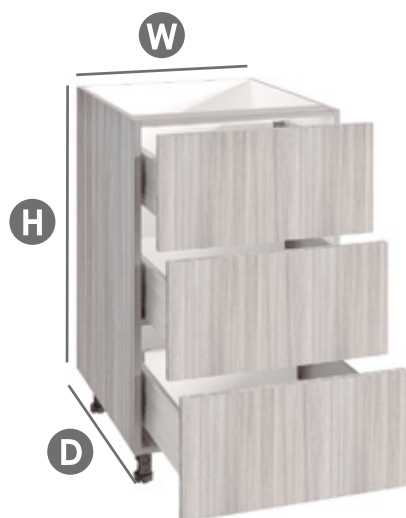

DB-3 - Drawer Base

COD	Width	Height	Depth
DB12-3	12"	30"	24"
DB15-3	15"	30"	24"
DB18-3	18"	30"	24"
DB21-3	21"	30"	24"
DB24-3	24"	30"	24"
DB27-3	27"	30"	24"
DB30-3	30"	30"	24"
DB36-3	36"	30"	24"

Setting

- Three identical drawers

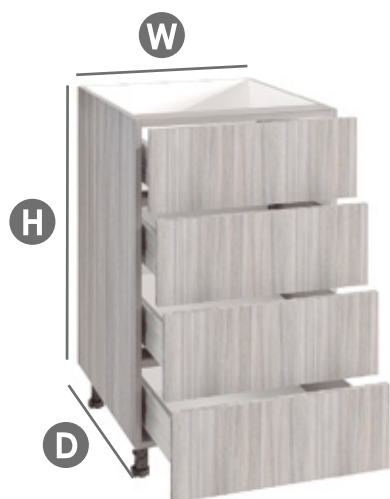

DB-4 - Drawe Base

COD	Width	Height	Depth
DB12-4	12"	30"	24"
DB15-4	15"	30"	24"
DB18-4	18"	30"	24"
DB21-4	21"	30"	24"
DB24-4	24"	30"	24"
DB27-4	27"	30"	24"
DB30-4	30"	30"	24"
DB36-4	36"	30"	24"

Setting

- Four identical drawers

Lower cabinets

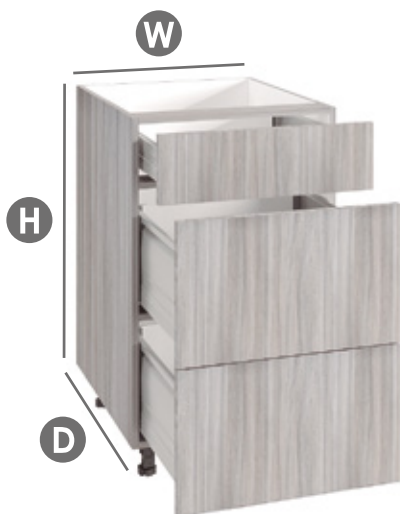

DB-1s - Drawer Base One Small

COD	Width	Height	Depth
DB12-1s	12"	30"	24"
DB15-1s	15"	30"	24"
DB18-1s	18"	30"	24"
DB21-1s	21"	30"	24"
DB24-1s	24"	30"	24"
DB27-1s	27"	30"	24"
DB30-1s	30"	30"	24"
DB36-1s	36"	30"	24"

Setting

- One small drawer
- Two large drawers



DB-2s - Drawer Base Two Small

COD	Width	Height	Depth
DB12-2s	12"	30"	24"
DB15-2s	15"	30"	24"
DB18-2s	18"	30"	24"
DB21-2s	21"	30"	24"
DB24-2s	24"	30"	24"
DB27-2s	27"	30"	24"
DB30-2s	30"	30"	24"
DB36-2s	36"	30"	24"

Setting

- Two small drawers
- One large drawer

Pantries



PCFD - Kitchen Pantry (Single door)

COD	Length	Height	Depth
PCFD1884	18"	84"	24"
PCFD1890	18"	90"	24"
PCFD1896	18"	96"	24"
PCFD2184	21"	84"	24"
PCFD2190	21"	90"	24"
PCFD2196	21"	96"	24"

Setting

- Door
- Shelves



PCFD - Kitchen Pantry (Double door)

COD	Length	Height	Depth
PCFD2484	24"	84"	24"
PCFD2490	24"	90"	24"
PCFD2496	24"	96"	24"
PCFD3084	30"	84"	24"
PCFD3090	30"	90"	24"
PCFD3096	30"	96"	24"

Setting

- Doors
- Shelves

Pantries



PC - Kitchen Pantry (Double door)

COD	Length	Height	Depth
PC1884	18"	84"	24"
PC1890	18"	90"	24"
PC1896	18"	96"	24"
PC2184	21"	84"	24"
PC2190	21"	90"	24"
PC2196	21"	96"	24"

Setting

- Doors
- Shelves



PC - Kitchen Pantry (Four doors)

COD	Length	Height	Depth
PC2484	24"	84"	24"
PC2490	24"	90"	24"
PC2496	24"	96"	24"
PC3084	30"	84"	24"
PC3090	30"	90"	24"
PC3096	30"	96"	24"

Setting

- Doors
- Shelves

Pantries



OVPC - Kitchen Pantry (Double door)

COD	Length	Height	Depth
OVPC2484	24"	84"	24"
OVPC2490	24"	90"	24"
OVPC2496	24"	96"	24"
OVPC3084	30"	84"	24"
OVPC3090	30"	90"	24"
OVPC3096	30"	96"	24"

Setting

- Doors
- Shelf
- Drawer

Lower bathroom cabinets

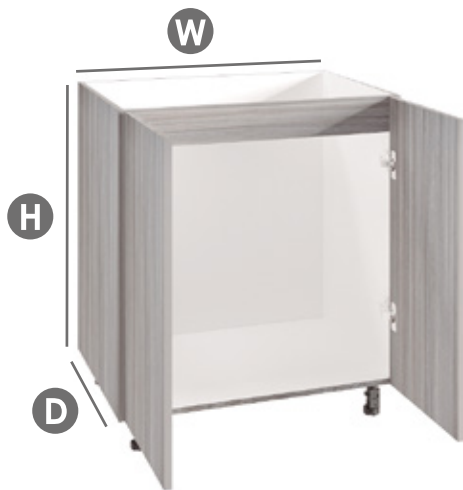
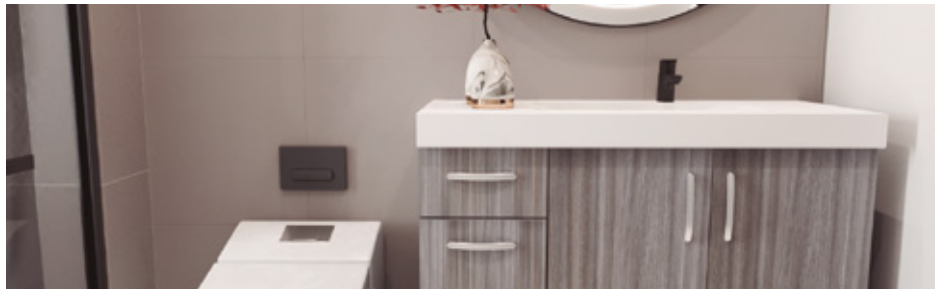

SVFD - Sink Vanity Full Door (Double door)

COD	Width	Height	Depth
SVFD24	24"	30"	21"
SVFD27	27"	30"	21"
SVFD30	30"	30"	21"
SVFD33	33"	30"	21"
SVFD36	36"	30"	21"

Setting

- Doors



VFD - Vanity Full Door (Single door)

COD	Width	Height	Depth
VFD12	12"	30"	21"
VFD15	15"	30"	21"
VFD18	18"	30"	21"
VFD21	21"	30"	21"

Setting

- Door
- Shelf



V - Vanity (Single door)

COD	Width	Height	Depth
V12	12"	30"	21"
V15	15"	30"	21"
V18	18"	30"	21"
V21	21"	30"	21"

Setting

- Drawer
- Door
- Shelf

Lower bathroom cabinets

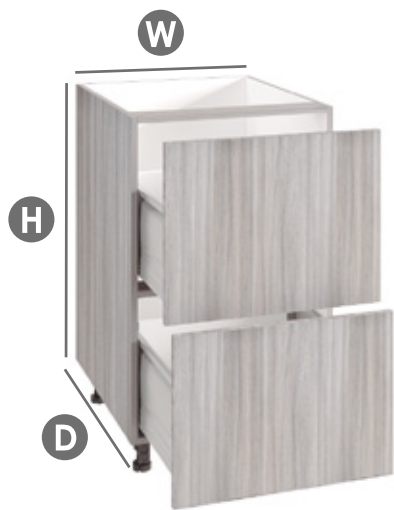
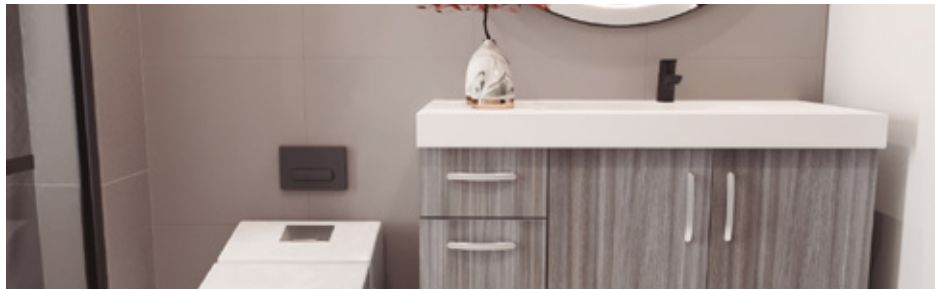

DV-2 - Drawer Vanity

COD	Width	Height	Depth
DV12-2	12"	30"	21"
DV15-2	15"	30"	21"
DV18-2	18"	30"	21"
DV21-2	21"	30"	21"
DV24-2	24"	30"	21"
DV27-2	27"	30"	21"
DV30-2	30"	30"	21"
DV36-2	36"	30"	21"

Setting

- Two identical drawers

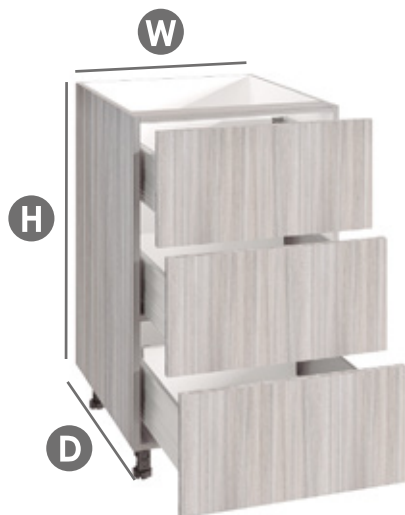

DV-3 - Drawer Vanity

COD	Width	Height	Depth
DV12-3	12"	30"	21"
DV15-3	15"	30"	21"
DV18-3	18"	30"	21"
DV21-3	21"	30"	21"
DV24-3	24"	30"	21"
DV27-3	27"	30"	21"
DV30-3	30"	30"	21"
DV36-3	36"	30"	21"

Setting

- Three identical drawers

Lower bathroom cabinets

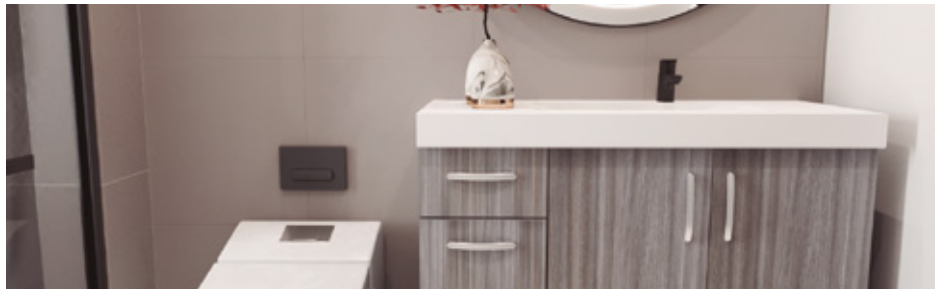

DV-4 - Drawer Vanity

COD	Width	Height	Depth
DV12-4	12"	30"	21"
DV15-4	15"	30"	21"
DV18-4	18"	30"	21"
DV21-4	21"	30"	21"
DV24-4	24"	30"	21"
DV27-4	27"	30"	21"
DV30-4	30"	30"	21"
DV36-4	36"	30"	21"

Setting

- Four identical drawers

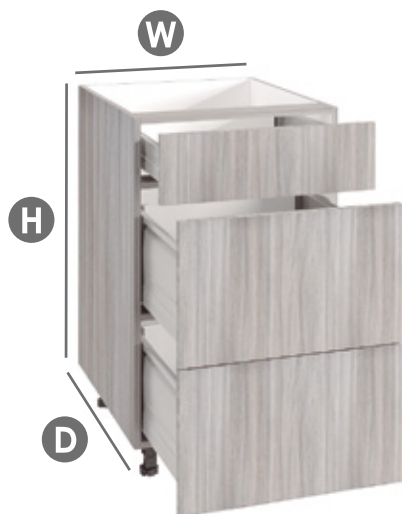

DV-1s - Drawer Vanity One Small

COD	Width	Height	Depth
DV12-1s	12"	30"	21"
DV15-1s	15"	30"	21"
DV18-1s	18"	30"	21"
DV21-1s	21"	30"	21"
DV24-1s	24"	30"	21"
DV27-1s	27"	30"	21"
DV30-1s	30"	30"	21"
DV36-1s	36"	30"	21"

Setting

- One small drawer
- Two large drawers

Lower bathroom cabinets

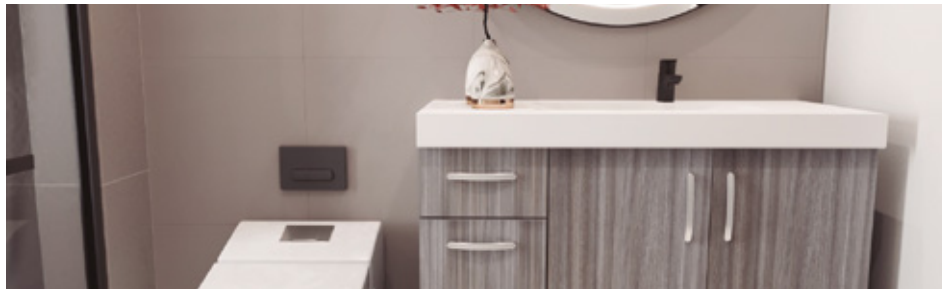

DV-2s - Drawer Vanity Two Small

COD	Width	Height	Depth
DV12-2s	12"	30"	21"
DV15-2s	15"	30"	21"
DV18-2s	18"	30"	21"
DV21-2s	21"	30"	21"
DV24-2s	24"	30"	21"
DV27-2s	27"	30"	21"
DV30-2s	30"	30"	21"
DV36-2s	36"	30"	21"

Setting

- Two small drawers
- One large drawer

Bathroom Pantries

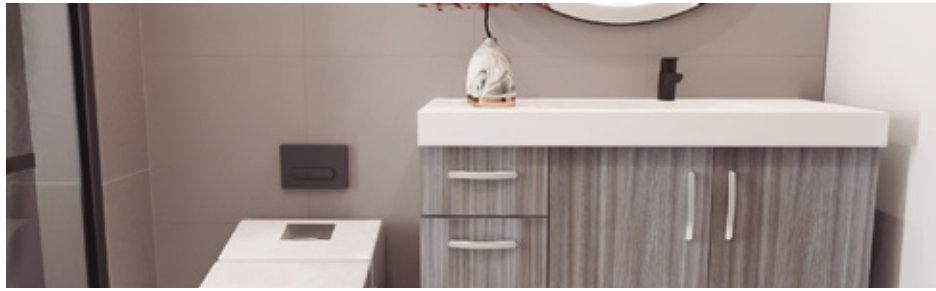

VPCFD - Bathroom Pantry

COD	Length	Height	Depth
VPCFD1884	18"	84"	21"
VPCFD1890	18"	90"	21"
VPCFD1896	18"	96"	21"
VPCFD2184	21"	84"	21"
VPCFD2190	21"	90"	21"
VPCFD2196	21"	96"	21"

Setting

- Door
- Shelves



VPCFD - Bathroom Pantry (Double door)

COD	Length	Height	Depth
VPCFD2484	24"	84"	21"
VPCFD2490	24"	90"	21"
VPCFD2496	24"	96"	21"
VPCFD3084	30"	84"	21"
VPCFD3090	30"	90"	21"
VPCFD3096	30"	96"	21"

Setting

- Doors
- Shelves

Bathroom Pantries

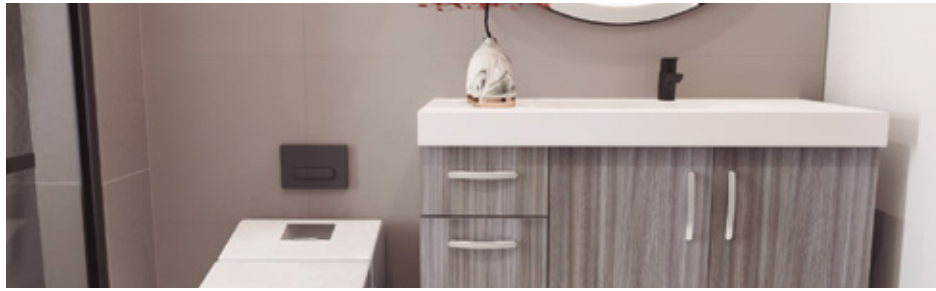

VPC - Bathroom Pantry (Double door)

COD	Length	Height	Depth
VPC1884 TK4	18"	84"	21"
VPC1890 TK4	18"	90"	21"
VPC1896 TK4	18"	96"	21"
VPC2184 TK4	21"	84"	21"
VPC2190 TK4	21"	90"	21"
VPC2196 TK4	21"	96"	21"

Setting

- Doors
- Shelves



VPC - Bathroom Pantry (Four doors)

COD	Length	Height	Depth
VPC2484	24"	84"	21"
VPC2490	24"	90"	21"
VPC2496	24"	96"	21"
VPC3084	30"	84"	21"
VPC3090	30"	90"	21"
VPC3096	30"	96"	21"

Setting

- Doors
- Shelves

Additional features

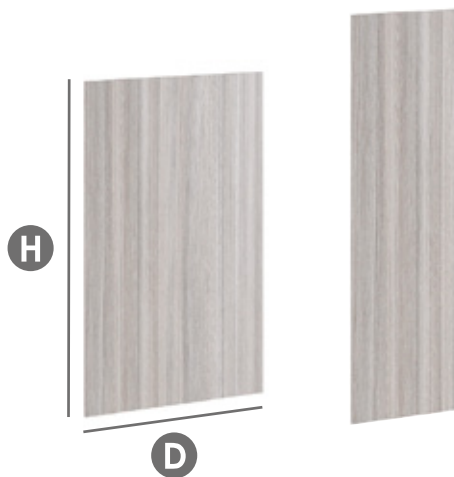

PN - Refrigerator panels

COD	Height	Depth
PN2484	84"	24"
PN2490	90"	24"
PN2496	96"	24"



F - Filler

COD	Height	Depth
F630	30"	6"
F636	36"	6"
F642	42"	6"



TK - Toe Kicks

COD	Length	Depth
TK4½96	4½"	96"
TK5¼96	5¼"	96"



Vanity tops



Oslo sink

COD	Length	Width	Depth
VBAN01-0056	18.8"	14.9"	4.8"
VBAN01-0038	18.8"	17"	4.8"
VBAN01-0047	24.8"	19"	4.9"
VBAN01-0046	31"	18.8"	5"
VBAN01-0045	37"	18.8"	5"

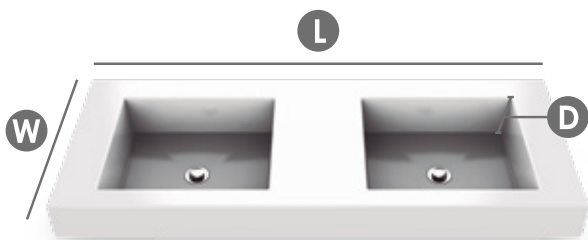

Oslo sink (Double bowl)

COD	Length	Width	Depth
VBAN01-0041	48.8"	18.8"	5"
VBAN01-0054	61"	19"	5"



18.8"X17"

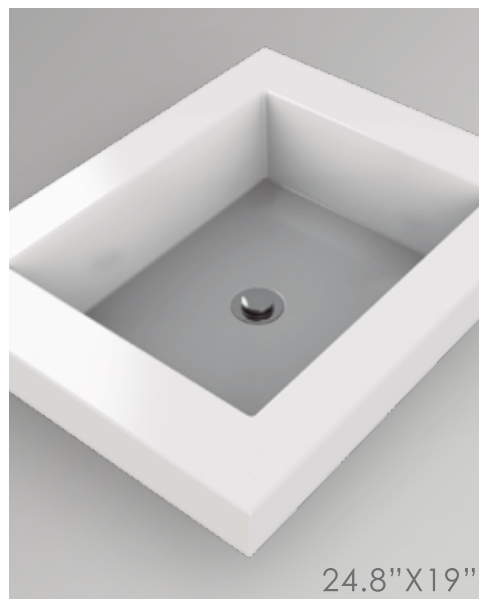

24.8"X19"

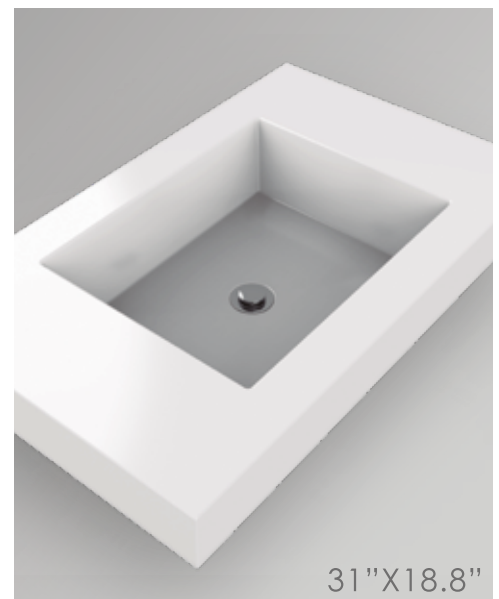

31"X18.8"

The dimensions of the vanity sinks have a tolerance of +/- 5mm by material characteristics.

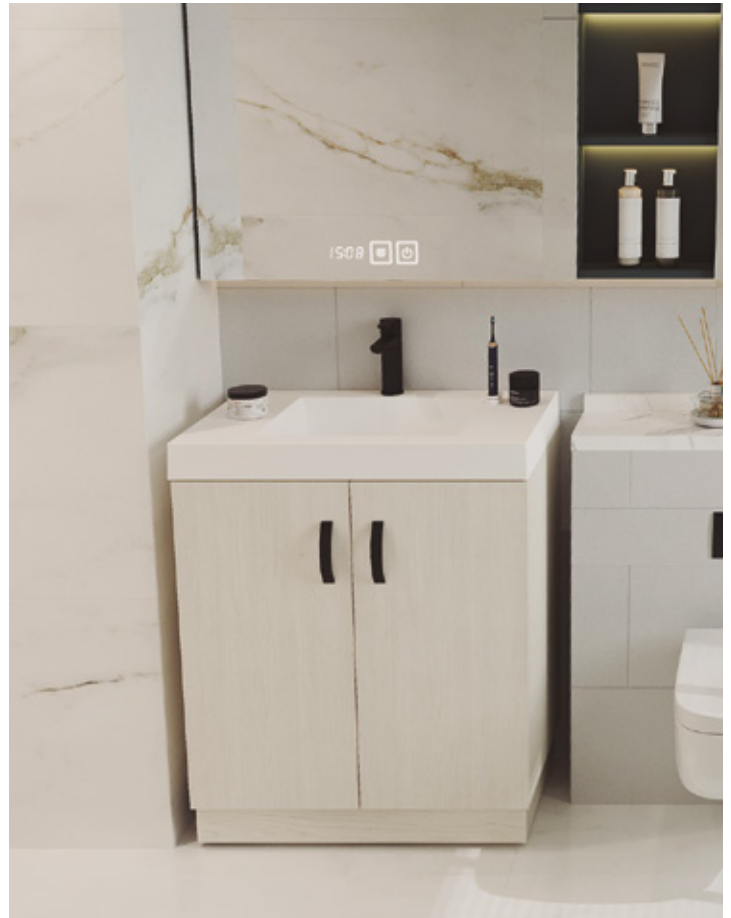

Available colors



GLACIAL

SAGANO

MITTE

Contact your sales rep to learn about other available colors

Construction cabinetry catalog



FIRPLAK



7955 West 20 ave,
Hialeah Florida 33014
+1 786 612 0675



Cl. 29 # 41 - 15
Itagüí, Antioquia.
+57 318 575 8648
www.firplak.com